

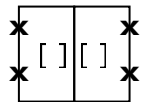
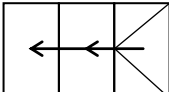
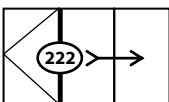
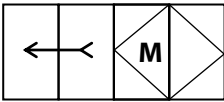
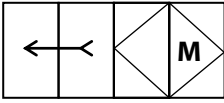
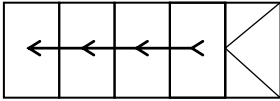
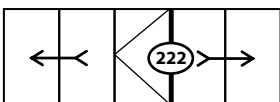
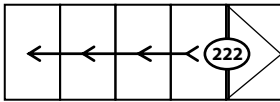
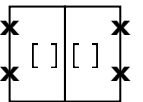
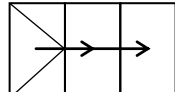
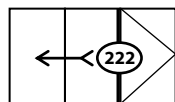
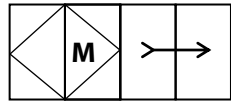
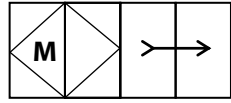
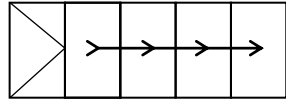
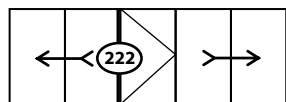
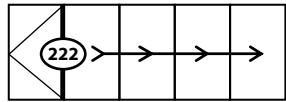

21ST CENTURY - TIMBERLOOK BI-FOLD ORDER		Page <input style="width: 40px;" type="text"/> of <input style="width: 40px;" type="text"/>
Customer <input style="width: 90%;" type="text"/>	Goods £ <input style="width: 40px;" type="text"/>	Order Date <input style="width: 80%;" type="text"/>
Address <input style="width: 90%;" type="text"/>	VAT £ <input style="width: 40px;" type="text"/>	Customer Signature (By Signing this order you agree to Affordable Window Systems Ltd. Terms & Conditions)
Tel No <input style="width: 90%;" type="text"/>	Total £ <input style="width: 40px;" type="text"/>	
Email/Fax <input style="width: 90%;" type="text"/>		Date Req. (ALSO INVOICE DATE) <input style="width: 80%;" type="text"/>
Post Code <input style="width: 20%;" type="text"/> Job Reference <input style="width: 70%;" type="text"/>	PRODUCTION CODE: <input style="width: 100%;" type="text"/>	
Contact <input style="width: 20%;" type="text"/> Quote Date <input style="width: 70%;" type="text"/>	DELIVERY CODE: <input style="width: 100%;" type="text"/>	

GLASS Tripleshield <input type="checkbox"/> Stay Cool <input type="checkbox"/> Unglazed <input type="checkbox"/> White PVCu <input type="checkbox"/> Rosewood ON BROWN <input type="checkbox"/> Oak ON CAMEL <input type="checkbox"/> ALL COLOURS BOTH SIDES BELOW ARE ON WHITE Black <input type="checkbox"/> Fir Green <input type="checkbox"/> Antique Pine (Irish Oak) <input type="checkbox"/> Grey <input type="checkbox"/> Chartwell Green <input type="checkbox"/> Cream <input type="checkbox"/> Polar White Foil <input type="checkbox"/> <small>PLEASE NOTE: The base profile is on white</small>	WARM EDGE Black <input type="checkbox"/> White <input type="checkbox"/> White <input type="checkbox"/> Black <input type="checkbox"/>	HANDLES White <input type="checkbox"/> Silver (Satin) <input type="checkbox"/> Gold (Bright) <input type="checkbox"/> Black <input type="checkbox"/> Silver (Bright) <input type="checkbox"/>	COLOUR OUTSIDE ONLY Oak on White <input type="checkbox"/> Fir Green on White <input type="checkbox"/> Rosewood on White <input type="checkbox"/> Cream on White <input type="checkbox"/> Polar White Foil on White <input type="checkbox"/> Chartwell Green on White <input type="checkbox"/> Black on White <input type="checkbox"/> on White <input type="checkbox"/> Antique Pine on White (Irish Oak) <input type="checkbox"/> Grey on White <input type="checkbox"/>
---	--	--	--

 * <input type="checkbox"/>  <input type="checkbox"/>  <input type="checkbox"/>  <input type="checkbox"/>  <input type="checkbox"/>  <input type="checkbox"/>  <input type="checkbox"/>  <input type="checkbox"/>	<p style="text-align: center;">All diagrams are <u>OUTSIDE VIEW ONLY</u></p> <p style="text-align: center;">Stack In <input type="checkbox"/> Stack Out <input type="checkbox"/></p> <table border="1" style="width: 100%; border-collapse: collapse;"> <thead> <tr> <th style="width: 50%;">Item</th> <th style="width: 50%;">Qty</th> </tr> </thead> <tbody> <tr> <td>Location</td> <td></td> </tr> <tr> <td>Width</td> <td></td> </tr> <tr> <td>Height</td> <td></td> </tr> <tr> <td>Cill</td> <td>None <input type="checkbox"/> Clip on Cill <input type="checkbox"/></td> </tr> <tr> <td>Trickle Vent</td> <td>No <input type="checkbox"/> Yes <input type="checkbox"/> <small>In 42mm Knock On only, show position on diagram</small></td> </tr> <tr> <td>*NEW* Tilt & Lift Blinds</td> <td>Yes <input type="checkbox"/></td> </tr> <tr> <td>Colour</td> <td></td> </tr> <tr> <td>Notes:</td> <td></td> </tr> </tbody> </table> <p style="text-align: center;">* On Slimline French Doors, Master Door will have a Lever/Lever handle and the slave will have a D-Pad to inside only</p>	Item	Qty	Location		Width		Height		Cill	None <input type="checkbox"/> Clip on Cill <input type="checkbox"/>	Trickle Vent	No <input type="checkbox"/> Yes <input type="checkbox"/> <small>In 42mm Knock On only, show position on diagram</small>	*NEW* Tilt & Lift Blinds	Yes <input type="checkbox"/>	Colour		Notes:		* <input type="checkbox"/>   <input type="checkbox"/>  <input type="checkbox"/>  <input type="checkbox"/>  <input type="checkbox"/>  <input type="checkbox"/>  <input type="checkbox"/>  <input type="checkbox"/>
Item	Qty																			
Location																				
Width																				
Height																				
Cill	None <input type="checkbox"/> Clip on Cill <input type="checkbox"/>																			
Trickle Vent	No <input type="checkbox"/> Yes <input type="checkbox"/> <small>In 42mm Knock On only, show position on diagram</small>																			
NEW Tilt & Lift Blinds	Yes <input type="checkbox"/>																			
Colour																				
Notes:																				

Sightlines: 132mm - Sliders/Slider 160mm - Traffic/Traffic 222mm - Slider/Traffic	Key:  Traffic Door →  Sliding Door	A traffic door has a conventional lever/lever locking handle, allowing one or two doors in the Bi-Fold door set to operate as a conventional back door. The minimum size of a sash is 500mm and the maximum is 750mm. Frames marked (222) have a wider sightline where a traffic door meets a sliding door.
---	--	--

TIMBERLOOK SLIM-SASH PVC-u BI-FOLDING DOORS

THRESHOLD OPTIONS

OPTION 1.

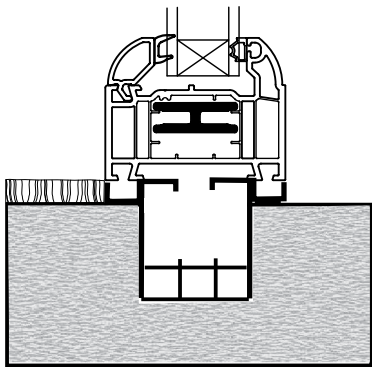

It is possible to recess the track 45mm into the floor

OPTION 2.

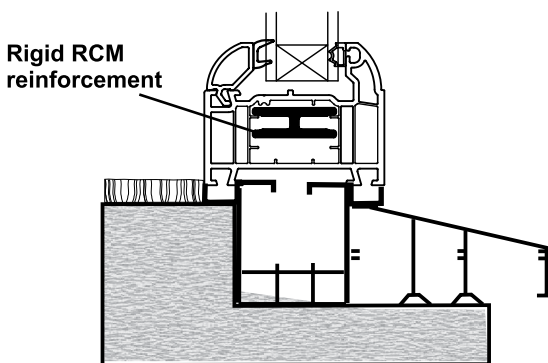

By lowering the external brickwork - the track can be installed flush with the internal floor

OPTION 3.

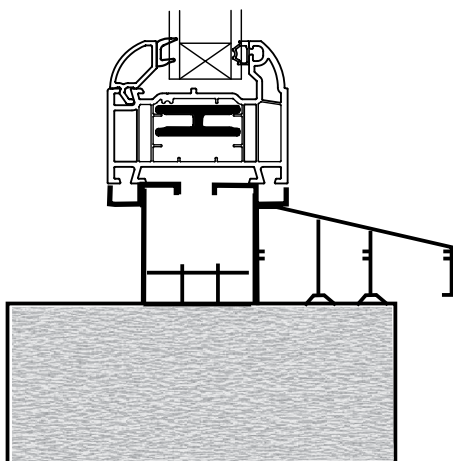

Fitted in the conventional way the upstand is only 52mm while conventional PVC-u Bi-Folding doors have an upstand between 100mm and 140mm

Timberlook Slim-Sash PVC-u Bi-Folding Doors have a sight line of 132mm sash to sash when doors slide to one side only.

This will double if doors are arranged to open both ways from the centre, however it is possible to have a traffic door one way and the other doors folding in the opposite direction and the sight line will only increase by 40mm where the doors meet.

The Bi-Fold doors can open in or out and are available up to 6 metres wide in any number of configurations.

The Timberlook 60mm sash has a combination of steel, aluminium and RCM reinforcement. The RCM is welded producing a weld strength which would normally require a much wider door sash.

The maximum sash width is 750mm and the minimum width is 500mm - the ideal width is 600mm to 650mm for optimal performance.

- The Timberlook Bi-Fold aluminium thresher is 52mm high.
- The Threshold can be fitted flush to the inside and outside floor and is also available with an external aluminium sill that does not increase the threshold height of 52mm.
- The rollers are concealed and are resistant to attack from potential intruders
- Hardened steel hook locks, dead bolts and top/bottom shootbolts are specified for high security and flat handles minimise stacking space when opened.
- The wheels which are stainless steel operate quietly and smoothly and have sealed bearings for maintenance free use.
- There are 4 expansion seals between each door.

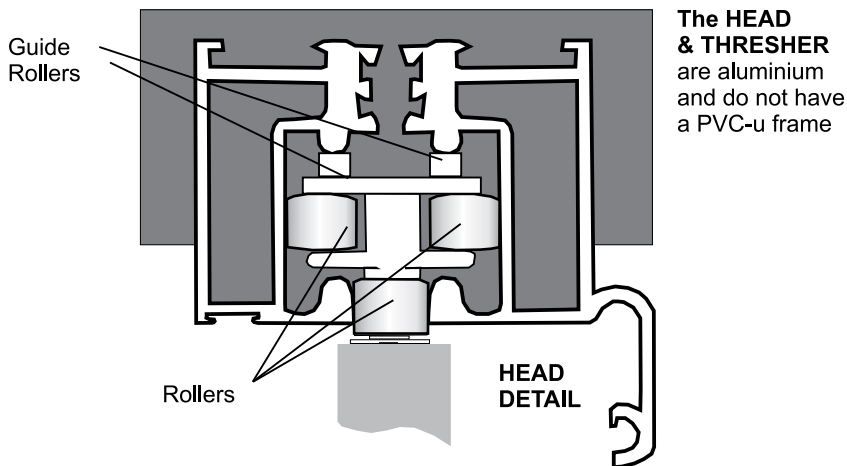

The Aluminium Head & Thresher encapsulate the running gear so that the door cannot be lifted from the track.